

TX6273/TX6274 TEMPERATURE SENSOR/TRANSMITTER



**TX6273
REMOTE
TEMPERATURE
SENSING PROBES**

**TX6274
INTEGRAL AIR
TEMPERATURE
SENSING PROBE**

INSTALLATION & OPERATING DATA

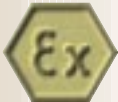

**ATEX
M1
GROUP I & II
INTRINSICALLY
SAFE**

- TUNNELS**
-
- MINING**
-
- TRENCHES**
-
- VESSELS**
-
- CONTAINERS**
-
- PROCESS
PLANTS**
-
- STORAGE AREAS**
-
- CONFINED AREAS**

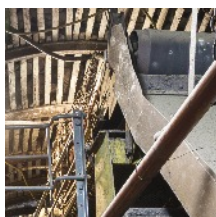
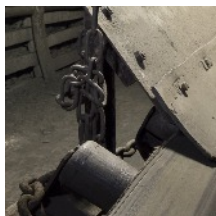
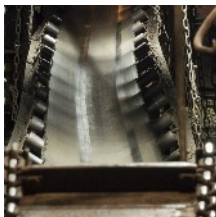

contents...

	page
1 PRINCIPLE OF OPERATION	2
2 APPLICATION	3
3 DIMENSIONS	3
4 TECHNICAL DETAILS	4
5 INSTALLATION	5
6 CONNECTIONS	7
7 CONTROLS AND INDICATORS	9
8 CALIBRATING THE OUTPUT SIGNAL	10
9 MAINTENANCE	11
10 APPROVALS AND CERTIFICATION	12

1 PRINCIPAL OPERATING FEATURES



High accuracy Temperature Sensor with an integral transmitter for machine temperature protection and plant safety monitoring.

- Version TX6273 for use with Trolex or similar remote temperature sensing probes. The input circuit may be compatible with either a KTY21-6 semiconductor temperature sensing element or a PT100 temperature sensing element.



Temperature sensing probes are and ordered separately from technical data sheet TX2070.



- Version TX6274 is provided with an integral sensing probe intended for monitoring local ambient air temperature supplied only with a KTY21-6 semiconductor sensing element.

- Conditioned analogue output signal possibilities:
4...20mA • 0.4...2V • 5...15Hz temperature calibrated.

- Optional LCD temperature readout.



- LED 'power on' indicator .



- Intrinsically safe version for use in Group I and Group II hazardous areas.

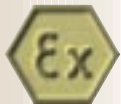

ATEX
M1
GROUP I & II
INTRINSICALLY
SAFE

2 APPLICATION



Temperature monitoring in critical installations where high accuracy and fast use is paramount, with the ability to transmit data over relatively long distances whilst maintaining stability and security of operation.

- Pipes, Ducting and Conduits.
- Vessels, Tanks, Storage Sumps and Reservoirs.
- Power Packs, Gearboxes, Generators and Hydraulic Power packs.
- Cooling Jackets, Cooling Systems, Refrigeration and Ventilation Systems.
- Transformers, Motors, Joint Boxes and Convertors.
- Environment, Roadways, Tunnels and Storage Areas.

A range of primary instrumentation and monitoring modules is available from Trolex to which the sensors can be directly connected to provide a flexible choice of display and control functions.



TRIP AMPLIFIER

for use with analogue output sensors.



CONFIGURABLE SENSOR CONTROLLER

for monitoring up to 8 analogue output sensors.



COMMANDER DISTRIBUTED I/O SYSTEM

for large scale general plant monitoring systems and the mining and tunnelling industries.

Ex
ATEX
M1
GROUP I & II
INTRINSICALLY
SAFE

3 DIMENSIONS

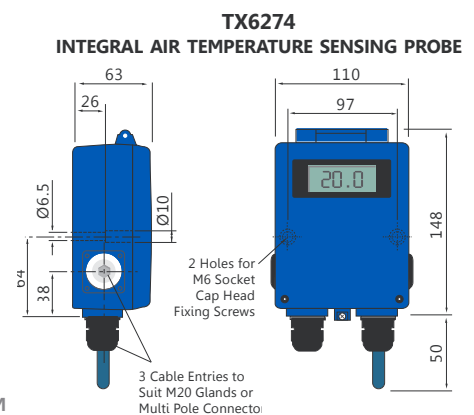
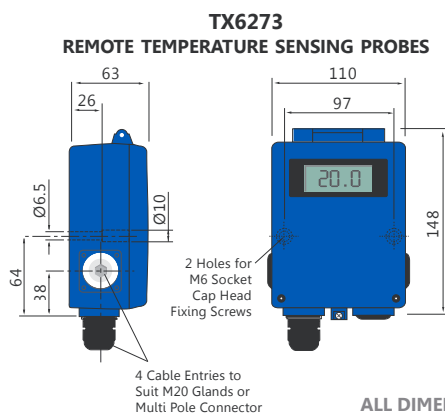

ALL DIMENSIONS IN MM

4 TECHNICAL DETAILS

4.1 Specification

	SENSOR INPUT TYPES	
	Semi-conductor	PT100 (TX6273 only)
Temperature Measuring Range:	0...100°C	0...200°C
Overall Accuracy:	±2%	1% (dependent on class of probe)
Repeatability:	±1%	1%
Ambient Temperature Limits:	-10...70°C	
Housing Material:	Stainless steel filled Polyamide 6	
Indicator:	Green 'Power on' LED (on versions without LCD)	
Protection Classification:	Dust and waterproof to IP65	
Electrical Connections:	4mm barrier terminals	
Nett Weight:	500g	
Information Display:	3½ digit LCD calibrated in °C	

4.2 Electrical Details

TX6273 TX6274 GENERAL PURPOSE & Ex GROUP II APPLICATIONS (24V dc)

Output:	4...20mA	
Max Load	600 ohms at 24V dc	
Supply	10...30V dc	
Current	Loop powered	

TX6273 TX6274 Ex GROUP I APPLICATIONS (12V dc)

Output:	0.4...2V	
Min Load	10k ohms	
Supply	9...16.5V dc	
Current	<10mA	

Output:	4...20mA	
Max Load	200 ohms at 12V dc	
Supply	9...16.5V dc	
Current	Loop powered	

Output:	5...15Hz	
Max Load	Opto isolated. 2mA max	
Supply	9...16.5V dc	
Current	30mA	



5 INSTALLATION

5.1 Conformity Check

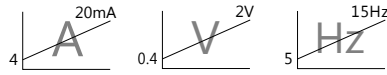

(Refer to Test Certificate provided with the sensor).

- Does the output signal of the sensor concur with the input requirement of the monitoring equipment being used?

12V dc

24V dc

- Is the correct supply voltage available for the sensor?

KTY21-6

PT100

- Does the type of input stage of the sensor concur with the temperature sensing probe being used (TX6273)?



- Does the temperature range of the process being monitored concur with the stated measuring range of the sensor?

GENERAL
PURPOSE



GROUP I



GROUP II

- Is the hazardous area classification correct?

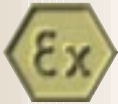

A T E X
M 1
GROUP I & II
INTRINSICALLY
SAFE

STANDARD OPTIONS AVAILABLE



TX6273.01 TEMPERATURE SENSOR/ TRANSMITTER **GROUP I TX6273.02**
TEMPERATURE SENSOR/ TRANSMITTER **GROUP II TX6273.03**
TEMPERATURE SENSOR/ TRANSMITTER **GENERAL PURPOSE**

OUTPUT SIGNAL	• 0.4...2V	(Group I only)	(11)
	• 4...20mA		(12)
	• 5...15Hz	(Group I only)	(13)

SENSOR TYPE	• KTY21-6 Semiconductor	(21)
	• PT100 Resistive (Group I only)	(23)

DISPLAY	• With display	(45)
	• Without display	(46)



TX6274.01 TEMPERATURE SENSOR/ TRANSMITTER **GROUP I TX6274.02**
TEMPERATURE SENSOR/ TRANSMITTER **GROUP II TX6274.03**
TEMPERATURE SENSOR/ TRANSMITTER **GENERAL PURPOSE**

OUTPUT SIGNAL	• 0.4...2V	(Group I only)	(11)
	• 4...20mA		(12)
	• 5...15Hz	(Group I only)	(13)

DISPLAY	• With display	(45)
	• Without display	(46)

5 INSTALLATION *continued*

5.2 TX6273 TEMPERATURE SENSOR/ TRANSMITTER Remote Temperature Sensing Probe



Mount the sensor in position and complete the electrical connections.

Refer to Section 6

Avoid any other cables in the vicinity that may radiate electromagnetic interference.

Ex
ATEX
M1
GROUP I&II
INTRINSICALLY
SAFE

5.3 TX6274 TEMPERATURE SENSOR/ TRANSMITTER Integral Temperature Sensing Probe



Mount the sensor in position and complete the electrical connections.

Refer to Section 6

Choose a location that is shielded from direct air movement to prevent cooling of the sensing probe and from direct sunlight to prevent warming of the sensing probe, both of which may distort the measured temperature.

6 CONNECTIONS

OUTPUT SIGNAL OPTIONS

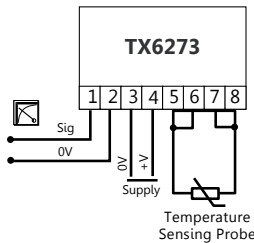

2 WIRE
PROBE CONNECTIONS

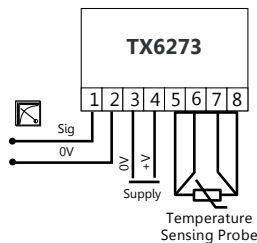

4 WIRE
PROBE CONNECTIONS
FOR LINE
COMPENSATION

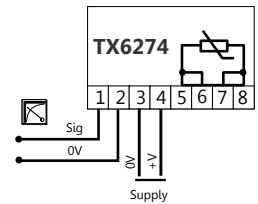

INTEGRAL AIR
TEMPERATURE SENSING
PROBE

6.1 0.4...2V Output Signal

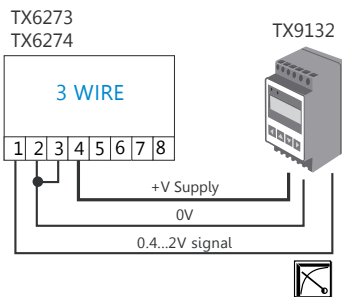

A low impedance two-wire voltage output signal requiring a separate power supply to the sensor. This can be derived from a Trip Amplifier or Programmable Sensor Controller, when one of those is used as the monitoring instrument.

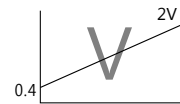

This connection configuration works well up to about 100 metres distance between the sensor and the monitoring equipment.

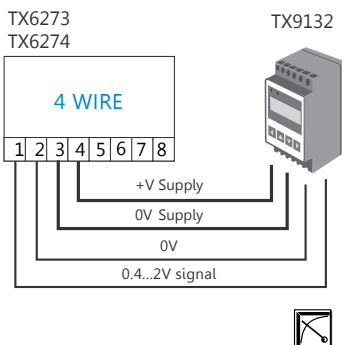

Both the signal and the power supply to the sensor are being carried in the common 0V conductor so at some point – influenced by the length of the cable and the resistance of the cable cores – the current flowing in the 0V conductor will impose an unacceptable voltage error onto the signal.

This effect can be reduced on long distance connections by increasing the size of the cable cores, or even better, running a separate 0V conductor to power the sensor enabling operating distances up to 1000m.

6.2 4...20mA Output Signal

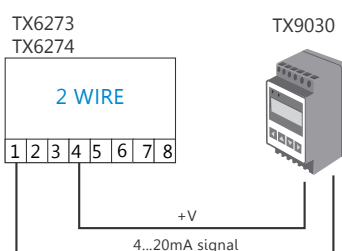

The output signal from terminals 1 and 4 is a conventional 4...20mA two wire current regulated signal loop.

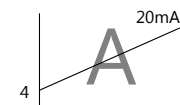

Sensor/transmitter using PT100 or semiconductor sensing probes have very low power consumption so the same loop can be used to also power the sensor. No separate power supply is needed.



6 CONNECTIONS continued

6.3 Hazardous Area Applications

6.3.1 GROUP I HAZARDOUS AREAS (MINING)

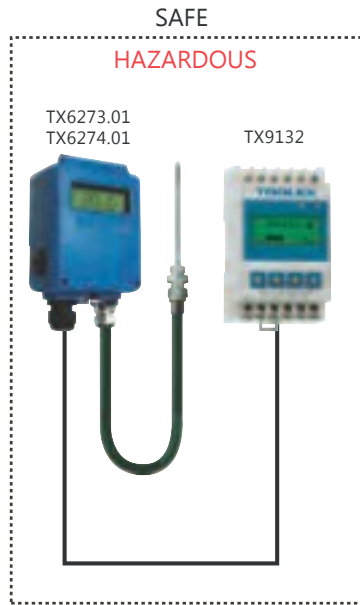

TX6273.01 TEMPERATURE SENSOR/ TRANSMITTER

TX6274.01 TEMPERATURE SENSOR/ TRANSMITTER



- Both output signal options of the sensor (0.4...2V and 4...20mA) are certified Intrinsically Safe for use in Group I hazardous areas (Mining) when used with approved equipment eg. TX9132 Trip Amplifier or a TX9042 Programmable Sensor Controller.
- THE COMPLETE SYSTEM, BOTH SENSOR AND MONITORING DEVICE, CAN BE MOUNTED IN THE HAZARDOUS AREA.

Ex

A T E X

M 1

GROUP I & II

INTRINSICALLY

SAFE

6.3.2 GROUP II HAZARDOUS AREAS

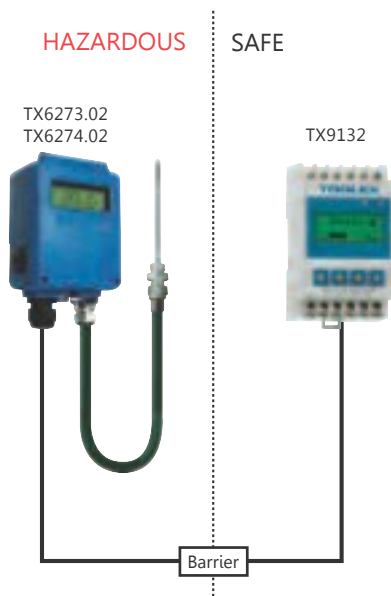

TX6273.02 TEMPERATURE SENSOR/ TRANSMITTER

TX6274.02 TEMPERATURE SENSOR/ TRANSMITTER



- This version of the sensor is certified Intrinsically Safe for use in Group II hazardous areas, zones 0, 1 and 2. It must be used in conjunction with a protective device:
 - Certified monitoring equipment or
 - Zener safety barrier or
 - Isolation safety barrier.
- ONLY THE SENSOR AND THE SENSING PROBE MAY BE MOUNTED IN THE HAZARDOUS AREA.

7 CONTROLS AND INDICATORS

TX6273	TEMPERATURE SENSOR/ TRANSMITTER	Remote Temperature Sensing Probe
TX6274	TEMPERATURE SENSOR/ TRANSMITTER	Integral Temperature Sensing Probe

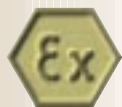
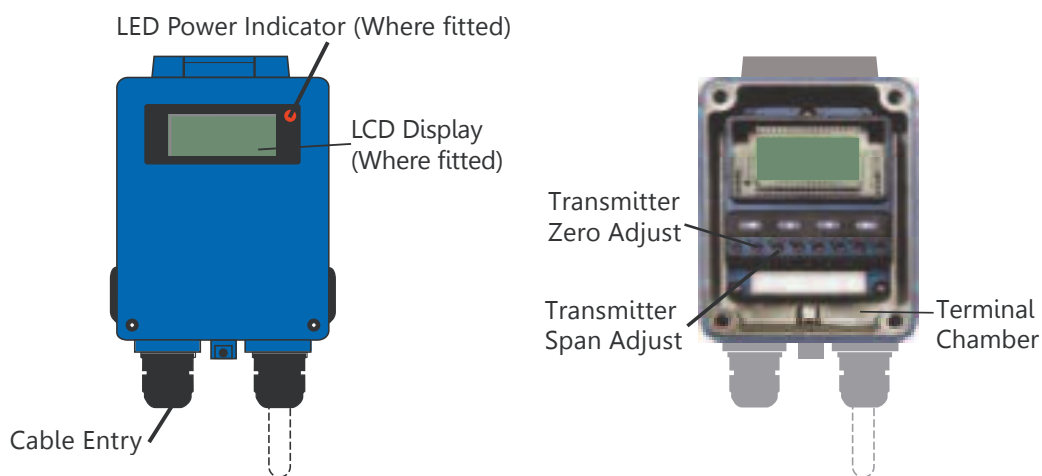

ATEX
M1
GROUP I & II
INTRINSICALLY
SAFE

8 CALIBRATING THE OUTPUT SIGNAL

The output signal transmitter of the sensor will have been accurately calibrated to the specified temperature range during manufacture and will remain essentially stable for an indefinite period.

- 4...20mA • 0.4...2V

It is good safety practice to check the condition of the signal at least annually. This will be automatically carried out when the sensor is returned to our Product Support Department for its annual safety check.

Alternatively the sensor output signal may be re-calibrated when required:

- Connect an accurate test instrument to the signal output circuit of the sensor and set the instrument to the appropriate measuring range (The LCD readout may be used for this purpose if fitted).
- Connect the normal supply voltage to the sensor terminals.
- Connect a calibrated resistance decade box to simulate the temperature sensing probe.
- Use the ZERO adjustment potentiometer to set the required minimum temperature level by using the appropriate value on the temperature/resistance chart (KTY21-6 or PT100).
- Do the same for the maximum temperature level using the SPAN adjustment potentiometer.

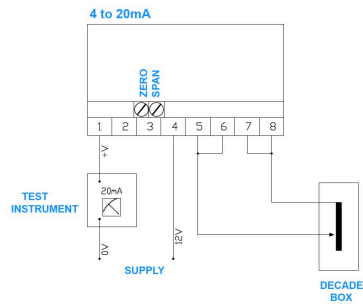
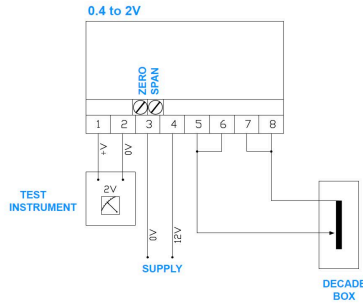

Temperature		Resistance	
°C	°F	KTY21-6*	PT100
-60	-58	—	76.33
-55	-67	490	78.32
-50	-58	518	80.31
-40	-40	570	84.27
-30	-22	625	88.22
-20	-4	684	92.16
-10	14	748	96.09
0	32	815	100.00
10	50	886	103.90
20	68	961	107.79
25	77	1000	109.73
30	86	1040	111.67
40	104	1123	115.54
50	122	1209	119.40
60	140	1300	123.24
70	158	1394	127.07
80	176	1492	130.89
90	194	1594	134.70
100	212	1700	138.80
110	230	1810	142.29
120	248	1923	146.06
125	257	1970	147.94
130	266	2041	149.82
140	284	2128	153.58
150	302	2235	157.31
160	320	—	161.04
170	338	—	164.76
180	356	—	168.46
190	374	—	172.16
200	392	—	175.84

*KTY 21-6 figures based on average temperature factor (kt) for sensor.



9 MAINTENANCE

9.1 Output Signal

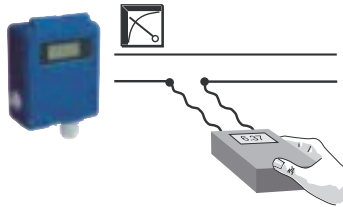

Check the response of the sensor at pre-determined intervals by applying an accurate temperature source to the sensing probe or by connecting a calibrated resistance decade box.

Compare the value of the output signal with the value applied.

Use the remote display of the monitoring system to measure the signal level or insert an approved test meter into the signal line. If the sensor is fitted with a digital display, then this also can be used to determine the level of the signal.

9.2 Annual Safety Check



The main transmitter itself will not normally require maintenance or calibration but it is advisable to return it to the Trolex Product Support Department for an annual safety check.

The main circuit module inside the sensor housing can be removed from the housing for maintenance purposes.

9.3 Damaged Sensors

A Sensor that has been dropped or damaged in any way should be taken out of service immediately for inspection, repair and re-calibration.

9.4 Record Keeping

Institute a regular calibration and maintenance procedure and keep a record.

Incorrect use of the Sensor or inadequate maintenance may not necessarily be self evident in the Sensor and consequently it must be regularly checked and maintained.

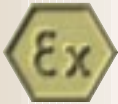

ATEX
M1
GROUP I & II
INTRINSICALLY
SAFE

10 APPROVALS AND CERTIFICATION

10.1 Intrinsically Safe



The instrument is certified Intrinsically Safe Group I and Group II apparatus for use in potentially explosive atmospheres to Euronorm standards when used with an approved power supply or safety barriers.

The sensor is designed to comply with the ATEX directive (94/9/EEC).

TX6273.01 TX6274.01 TEMPERATURE SENSOR/TRANSMITTER

GROUP I: EEx ia I: Sira 99ATEX2132X

TX6273.02 TX6274.02 TEMPERATURE SENSOR/ TRANSMITTER

GROUP II: EEx ia IIC T4: Sira 99ATEX2132X

10.2 Electro Magnetic Compatibility.



The instrument is designed to comply with the EC directive on EMC (89/336/EEC).

10.3 Special Conditions of Safe Use

The equipment should not be installed where the external conditions could cause a build-up of electrostatic charges on their non-conducting surfaces. Additionally, the equipment shall only be cleaned with a damp cloth.

10.4 Compliance with ATEX Directives



Instructions specific to hazardous area installations (European ATEX Directive 94/9/EC, Annex II, 1.0.6.)

The following applies to equipment covered by certificate number Sira 99ATEX2131X:

1. To comply with the requirements for intrinsic safety, the equipment must be supplied only from associated apparatus with an appropriate safety description matching the input parameters detailed in the certificate.
2. The equipment has not been assessed as a safety-related device (Annex II, 1.5.1 to 1.5.8).
3. The Group II version of the equipment may be used in all hazardous zones with all gases with temperature classes T1, T2, T3 and T4.
4. The equipment is only certified for use in ambient temperatures in the range -20°C to +60°C and should not be used outside this range.
5. Subject to the applicable code of practice, the enclosure may be temporarily opened and the equipment worked on 'live' as all sparks which are inadvertently produced are non-incendive.
6. Installation shall be carried out in accordance with the applicable code of practice by suitably-trained personnel.
7. A special condition of installation and use applies to the equipment. Those installing or inspecting this equipment must have access to the contents of the certificate.
8. Adjustments to this equipment affect operation only and have no effect on intrinsic safety.
9. Repair of this equipment shall be carried out in accordance with the applicable code of practice.
10. The equipment relies on the following materials used in its construction:

Enclosure:	Polycarbonate
Window:	Polycarbonate

The equipment should not be exposed to substances, which could degrade these materials.

ATEX
M1
GROUP I & II
INTRINSICALLY
SAFE

10 APPROVALS AND CERTIFICATION *continued*



Hinweise für die Installation in explosionsgefährdeten Bereichen (gem. European ATEX Directive 94/9/EC, Annex II, 1.0.6.)

Folgende Punkte betreffen die Geräte mit Zertifikat Nr. Sira 99ATEX2131X:

1. Um den Anforderungen der Eigensicherheit zu genügen, dürfen die Geräte ausschließlich über eine Stromversorgung betrieben werden die eine geeignete Sicherheitsklasse hat und die den Fingangsparametern im Zertifikat entspricht.
2. Die Geräte sind nicht als Sicherheitsgeräte (gem. Annex II, 1.5.1 bis 1.5.8) eingestuft.
3. Die Geräteversion für Gruppe II kann in allen gefährdeten Bereichen mit allen Gasen mit Temperaturklassen T1, T2, T3 und T4 betrieben werden.
4. Die Geräte sind nur für Umgebungstemperaturen von -20°C bis +60°C zertifikat und sollten außerhalb dieses Bereiches nicht betrieben werden.
5. Entsprechend den geltenden Vorschriften kann das Gehäuse zeitweise geöffnet und das Gerät weiterbetrieben werden, da alle unbeabsichtigt erzeugten Funken nicht zündfähig sind.
6. Die Installation muß entsprechend den geltenden Vorschriften von entsprechend qualifiziertem Personal ausgeführt werden.
7. Für die Installation und den Betrieb gilt eine besondere Vorschrift: Personal für die Installation und Wartung muß Zugang zum Inhalt des Zertifikates haben.
8. Einstellungen am Gerät wirken betreffen nur den Betrieb und haben keine Auswirkungen auf die Eigensicherheit.
9. Die Reparatur dieses Gerätes ist entsprechend den geltenden Vorschriften auszuführen.
10. Das Gerät ist mit folgenden Materialien aufgebaut:
Gehäuse: Polycarbonat
Fenster: Polycarbonat

Das Geräte darf Substanzen, die dieses Material angreifen, nicht ausgesetzt werden.



Informatie bedoeld voor installaties in explosie gevaarlijke ruimtes. (Europese ATEX directieve 94/9/EC, annex II, 1.0.6.)

Het volgende is van toepassing op apparatuur, volgens certificaat nummer Sira 99ATEX2131X:

1. Om te voldoen aan de eisen van intrinsiek veiligheid, mag het apparaat alleen worden gevoed door instrumenten die voldoet aan de veiligheidsvoorschriften volgens de ingangsparameters gespecificeerd in het certificaat.
2. Het apparaat is niet bedoeld als een veiligheid gerelateerd instrument (Annex II, 1.5.1 tot 1.5.8).
3. De groep II versie van het apparaat mag worden gebruikt in alle explosie gevaarlijke ruimtes bij alle gassen met temperatuur klassen T1, T2, T3 en T4.
4. De apparatuur is alleen gecertificeerd voor gebruik bij omgevingstemperatuur van -20°C tot +60°C en mag dit bereik niet te buiten gaan.
5. Met inachtneming van de van toepassing zijnde voorschriften, mag de behuizing tijdelijk worden geopend terwijl het instrument in bedrijf is, omdat alle onopzettelijk gegenereerde vonken geen ontbranding kunnen veroorzaken.
6. Installatie moet worden uitgevoerd in overeenstemming met de gebruikelijke voorschriften, door voldoende gekwalificeerd personeel.
7. Speciale installatie- en gebruiksvoorschriften zijn van toepassing. Zij die het apparaat installeren of inspecteren, moeten de beschikking hebben over dit certificaat.
8. Verstellingen aan dit instrument hebben alleen effect op de werking maar hebben geen invloed op de intrinsiek veiligheid.
9. Reparatie van de apparatuur zal worden uitgevoerd in overeenstemming met de gebruikelijke voorschriften.

10. De volgende materialen zijn gebruikt in de constructie:

Behuizing:	Polycarbonaat
Venster:	Polycarbonaat

Deze materialen mogen niet in aanraking komen met substanties die de materialen kunnen aantasten.

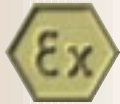

ATEX
M1
GROUP I&II
INTRINSICALLY
SAFE

10 APPROVALS AND CERTIFICATION *continued*



Spesifikk informasjon om risiko på installasjoner i eksplosjonsfarlige soner (ref. Europeisk ATEX Direktiv 94/9/EC, Anneks II, 1.0.6.)

Følgende brukes til utstyr dekket av sertifikatnummer Sira 99ATEX2131X:

1. For å imøtekomme/etterkomme krav for egensikkert, må utstyret være forsynt/tilført kun fra tilknyttede apparater med korresponderende sikkerhetsbeskrivelse tilpasset inngangsparametrene beskrevet i sertifikatet.
2. Utstyret har ikke blitt vurdert som en sikkerhetsrelatert innretning. (Anneks II, 1.5.1 til 1.5.8).
3. Utstyr i Gruppe II versjonen, kan brukes i alle faresoner med all gass med temperatur klasse T1, T2, T3 og T4.
4. Utstyret er kun sertifisert for bruk i omgivelsestemperaturer i område -20°C til $+60^{\circ}\text{C}$ og må ikke brukes utenfor dette området.
5. I henhold til gjeldende retningslinjer kan sensorhuset midlertidig åpnes og utstyret vedlikeholdes under aktivitet, da antennelig gnistfare ikke finner sted.
6. Installering skal bli utført i samsvar med gjeldende regler av kompetent personale.
7. En spesiell betingelse for installering og anvendelse av utstyret stilles: De som installerer eller inspiserer utstyret må ha adgang til innholdet i sertifikatet.
8. Regulering/justering av utstyret virker kun på driften, og har ingen virkning på kretsens egensikkerhet.
9. Reparasjon av utstyret skal bli utført i samsvar med gjeldende regler.
10. Utstyret henspilles til de følgende materialer benyttet i konstruksjonen som:

Hus:	Polycarbonate
Vindu:	Polycarbonate

Utstyret kan ikke bli utsatt for forhold, som kan degradere materialet.



Instrucciones específicas para instalaciones en zonas peligrosas (Directiva Europea ATEX 94/9/EC, Annex II, 1.0.6.)

Los puntos siguientes son aplicables al equipamiento cubierto por el certificado Sira número 99ATEX2131X:

1. Para cumplir con los requerimientos de la seguridad intrínseca, el equipamiento debe ser alimentado sólo por aparatos asociados con una descripción de seguridad apropiada que cumpla con los parámetros de entrada que se detallan en el certificado.
2. El equipamiento no ha sido diseñado como un dispositivo de seguridad (safety related) (Anexo II, 1.5.1 to 1.5.8).
3. La versión Grupo II de este equipamiento se puede utilizar en todas las zonas peligrosas que contengan gases con grupos de temperatura T1, T2, T3 y T4.
4. El equipamiento sólo está certificado para uso a temperatura ambiente en el rango de -20°C a $+60^{\circ}\text{C}$ y no debería ser usado fuera de ese rango.
5. Dependiendo del método de trabajo aplicable, la envolvente se puede abrir temporalmente y trabajar con el instrumento ya que todas las chispas que se pudiesen producir no producen explosión de ningún gas ni polvo inflamable.
6. La instalación deberá ser llevada a cabo en concordancia con el método de trabajo aplicable por personal adecuadamente formado.
7. Se aplican a este equipamiento unas condiciones de instalación y de uso especiales. Aquellos que instalen o inspeccionen este equipamiento deben tener acceso a los contenidos del certificado.
8. Los ajustes a estos instrumentos afectan sólo al funcionamiento y no tienen ningún efecto en la seguridad intrínseca.
9. Las reparaciones de estos instrumentos deberán realizarse en concordancia con el método de trabajo aplicable.
10. El equipamiento se basa en los siguientes materiales usados en su construcción:

Envolvente:	Polycarbonato
Ventana:	Polycarbonato

El equipamiento no debe ser expuesto a sustancias que puedan degradar estos materiales.

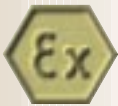

ATEX
M1
GROUP I&II
INTRINSICALLY
SAFE

PROTECTING THE ENVIRONMENT



Many of our products are often used to monitor the quality of environmental conditions consequently Trolex is also particularly aware of the need to protect human health and the environment in which we live.

The Company has instituted a radical environment protection policy to ensure that all aspects of our manufacturing programme have the minimum possible detrimental impact on the environment. This covers all stages beginning with sustainable product design supported by careful selection of the materials used in their production, through to managed recovery and disposal at the end of the useful life of a product.

This policy also incorporates the principles of the Waste Electrical and Electronics Equipment (WEEE) directive, and the associated Restriction of Hazardous Substances (RoHS) directive, to be implemented in EU countries.

Progress is already well advanced on the introduction of a completely new range of products that maximise the central principle of sustainable design with the intention of reducing the end-of-life cost to the end user.

All Trolex products are manufactured to exacting standards in accordance with our stringent quality control ethos. Having chosen to use one of our products will, in itself, guarantee extended durability and a long operating life, endorsed by our commitment to recycling and recovery.

- All packaging materials are carefully selected to be bio-degradable or re-cycleable where possible.
- All plastic materials are identified for recycling purposes and re-cycled materials are used where it is possible to do so.

- Printing paper and material are sourced from suppliers that have a declared environmental management system.
- Product design centred around high quality and long term durability. Modular architecture both in construction and software design suitable for future upgrades and adaptability to alternative duty.
- Ease of product disassembly, minimisation of fixing devices, and clear separation of functional parts to benefit re-use and re-cycling.
- Control and monitoring of suppliers of components and sub-assemblies. Deal only with suppliers that have a defined commitment to environmental monitoring principles.
- Control the use of restricted substances within the design process. Deal only with suppliers that have a defined commitment to the control of restricted substances.
- Provide an efficient high speed service within Trolex for repair, refurbishing and conversion of products for alternative duty.
- Provision of an end-of-life product Take-back service for recovery, re-use, and recycling of electrical and electronic components. Retain the packaging of a new product and re-use it to return the device to us at the end of its working life. Trolex will guarantee to recover all materials and components, where practicable and arrange for them to be re-cycled in an appropriate and in a safe manner.



ATEX
M1
GROUP I & II
INTRINSICALLY
SAFE