

TX6620/TX6630 INTRINSICALLY SAFE POWER SUPPLIES (Exi)

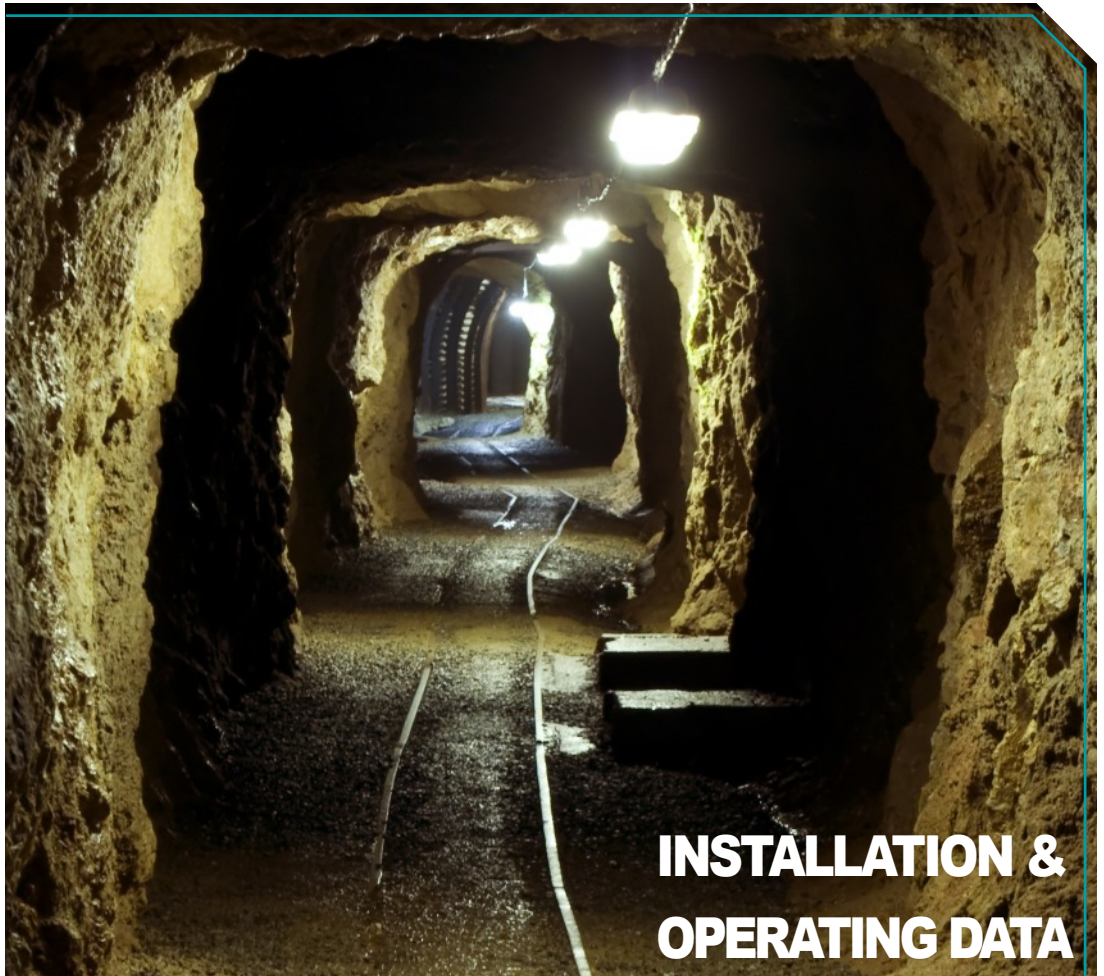

INSTALLATION & OPERATING DATA



ATEX
M2/M1
GROUP I
INTRINSICALLY
SAFE

DESIGNED TO
CONVERT AC SUPPLY
VOLTAGE INTO A
STABILISED AND
REGULATED LS SOURCE
FOR
SUPPLYING POWER
TO APPROVED
SENSORS AND
ELECTRONIC CONTROL
DEVICES

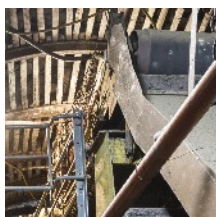
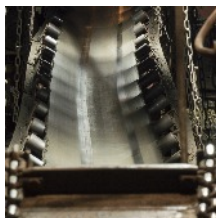
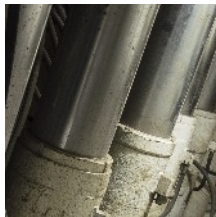

contents...

	page
1 PRINCIPAL OPERATING FEATURES	2
2 TECHNICAL DETAILS	2
3 CONFORMITY CHECK	3
4 DIMENSIONS AND CONNECTIONS	4
5 ISOLATING RELAYS	5
6 PRECAUTIONS	7
7 APPROVALS AND CERTIFICATION	8

INSTALLATION & OPERATING DATA

1 PRINCIPAL OPERATING FEATURES

The TX6630 Series Power Supply chassis will convert an ac supply voltage into a stabilised and regulated Intrinsically Safe source for supplying power to approved sensors and electronic control devices.

- Input voltage options: 110V ac, 230V ac
- The input supply is protected by two primary fuses.
- There is a choice of Intrinsically Safe output voltage: 12V dc or 7.5V dc.
- The output circuit is resistively limited in accordance with certification standards for Intrinsically Safe, ia, equipment.
- The TX6630 Series Power Supply Chassis may be fitted and wired into an existing Exd housing (specific system certification may also be required) or into a standard protective housing that is in a SAFE AREA.
- The TX6620 Series version is the TX6630 Series Power supply chassis mounted in a Trolex Exd housing for use in a Group I hazardous area.
- Intrinsically Safe isolation relays may be supplied with all versions for switching control currents emanating from other Exd enclosures or high voltage systems.

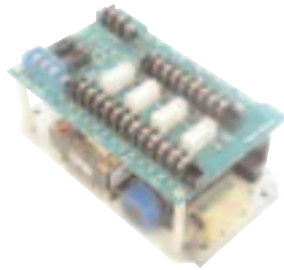
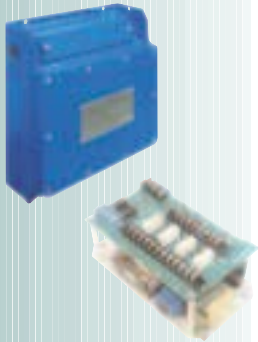

ATEX
M2/M1
GROUP I
INTRINSICALLY
SAFE

2 TECHNICAL DETAILS

	TX6625/35	TX6626/36
Nominal Output Voltage:	7.5V dc	12V dc
Maximum Output Current:	1.5A	0.5A
Input Supply:	110V ac or 230V ac, 50/60Hz	
Operating Temperature Limits:	-5°C...+70°C	
Relay Contact Rating: (where fitted)	10A 230V ac	

INSTALLATION & OPERATING DATA

3 CONFORMITY CHECK

110V ac • 230V ac

- Does the supply voltage marked on the product agree with the locally available supply?

0.5A • 1.5A

- Check that the output current rating marked on the product is adequate for the total current demand of the system being installed.

Exd or Safe Area

- Is the Power Supply mounted in the correct enclosure for the application?

Exi Group II

- Ensure that the Power Supply certification details are fully compliant with the monitoring system requirements.

If in any doubt, please contact the Trolex Sales department.

7.5V dc or 12V dc

- Is the output voltage correct for the system being used?

7.5V dc or 12V dc

- If isolating relays are fitted, is the voltage rating of the coils correct?

- If isolating relays are fitted, are the relay parameters suitable for the load being switched?

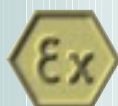

ATEX
M2/M1
GROUP I
INTRINSICALLY
SAFE

OPTIONS AVAILABLE



TX6625 INTRINSICALLY SAFE POWER SUPPLY
in Exd Housing

TX6626 INTRINSICALLY SAFE POWER SUPPLY
in Exd Housing

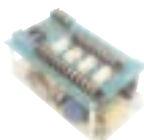

TX6635 INTRINSICALLY SAFE POWER SUPPLY
CHASSIS (Supplied loose, ready for fitting
and wiring)

TX6636 INTRINSICALLY SAFE POWER SUPPLY

	Nominal O/P Voltage	Max O/P Current
TX6625	7.5V dc	1.5A
TX6626	12V dc	0.5A
TX6635	7.5V dc	1.5A
TX6636	12V dc	0.5A

Option Codes:

110V ac Input (.105)

230V ac Input (.106)

INSTALLATION & OPERATING DATA

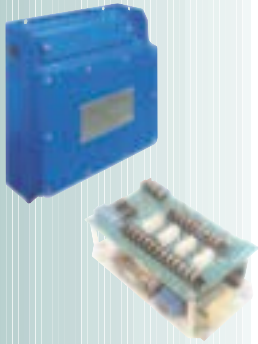

4 DIMENSIONS

4.1 TX6635/6 INTRINSICALLY SAFE POWER SUPPLY CHASSIS

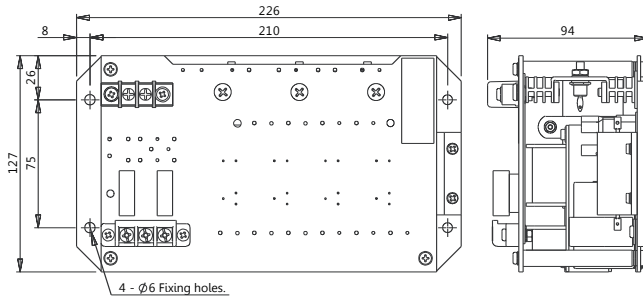

ALL DIMENSIONS IN MM

CONNECTIONS

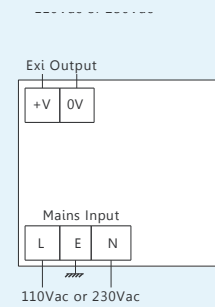

4.2 TX6625/6 INTRINSICALLY SAFE POWER SUPPLY in Exd HOUSING

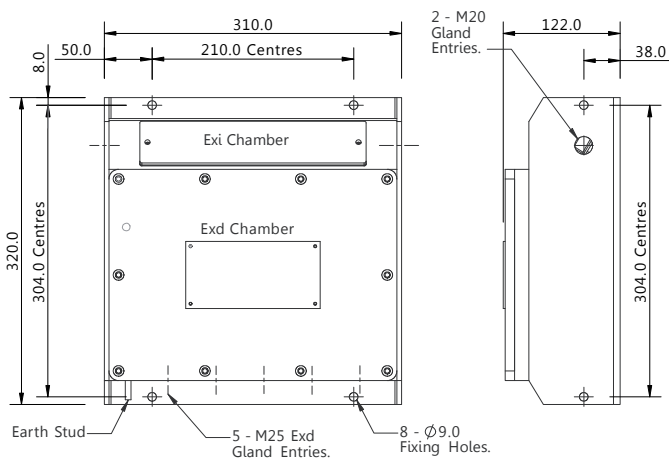

ALL DIMENSIONS IN MM

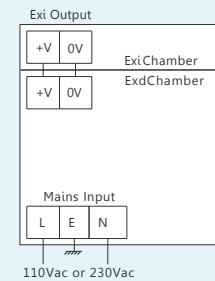

ATEX
M2/M1
GROUP I
INTRINSICALLY
SAFE

INSTALLATION & OPERATING DATA

5 ISOLATING RELAYS

Isolating relays may be combined with the Power Supply. The operating coils of the relays are Intrinsically Safe and the contacts are clearance compatible for switching non-intrinsically safe apparatus or devices in separate Exd enclosures (eg. P130 pilot circuits).

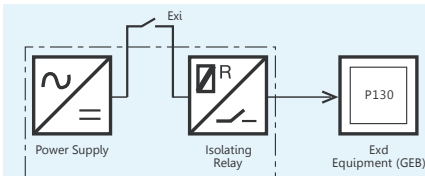

A standard power supply chassis is fitted and wired with four independent relays with field connection facilities for coils and contacts. The coils can be rated for either 7.5V dc or 12V dc operation.

5.1 Technical Details

	Nominal O/P Voltage	Max O/P Current	Relay Contact Rating	Coil Resistance
TX6625	7.5V dc	1.5A	10A 230V ac	324 Ohms
TX6626	12V dc	0.5A	10A 230V ac	580 Ohms
TX6635	7.5V dc	1.5A	10A 230V ac	324 Ohms
TX6636	12V dc	0.5A	10A 230V ac	580 Ohms

5.2 Dimensions

5.2.1 TX6635.19 INTRINSICALLY SAFE POWER SUPPLY CHASSIS with RELAYS in Exd HOUSING TX6636.19

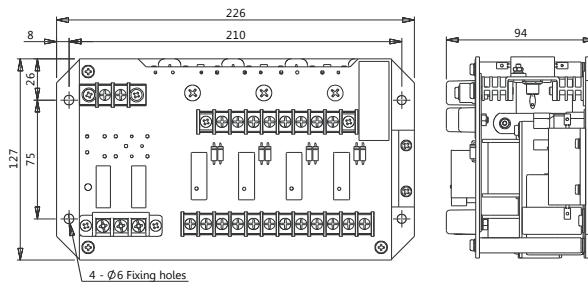

ALL DIMENSIONS IN MM

Connections

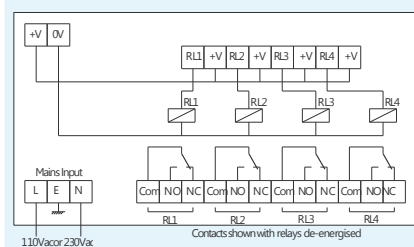

5.2.2 TX6625.19 INTRINSICALLY SAFE POWER SUPPLY in Exd HOUSING, with 4 ISOLATING RELAYS TX6626.19

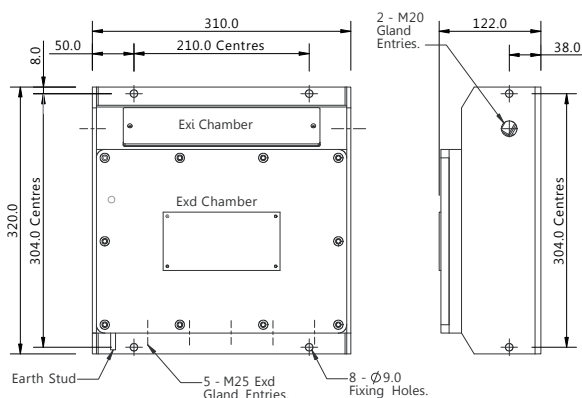

ALL DIMENSIONS IN MM

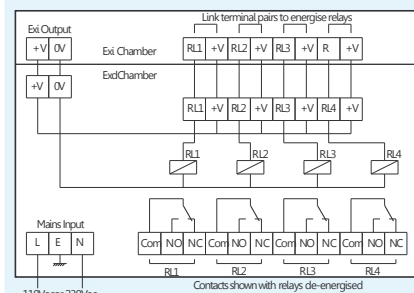

INSTALLATION & OPERATING DATA

5 ISOLATING RELAYS continued

5.2.3 OPTIONS AVAILABLE

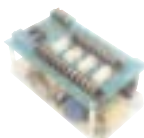

TX6625.19 INTRINSICALLY SAFE POWER SUPPLY with RELAYS in Exd Housing

TX6626.19 INTRINSICALLY SAFE POWER SUPPLY with RELAYS in Exd Housing

TX6635.19 INTRINSICALLY SAFE POWER SUPPLY CHASSIS with RELAYS (Supplied loose, ready for fitting and wiring)

TX6636.19 INTRINSICALLY SAFE POWER SUPPLY CHASSIS with RELAYS (Supplied loose, ready for fitting and wiring)

	Nominal O/P Voltage	Max O/P Current	Relay Contact Rating
TX6625.19	7.5V dc	1.5A	10A 230V ac
TX6626.19	12V dc	0.5A	10A 230V ac
TX6635.19	7.5V dc	1.5A	10A 230V ac
TX6636.19	12V dc	0.5A	10A 230V ac

Option Codes:

110V ac Input (.105)
230V ac Input (.106)

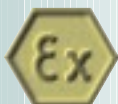

ATEX
M2/M1
GROUP I
INTRINSICALLY
SAFE

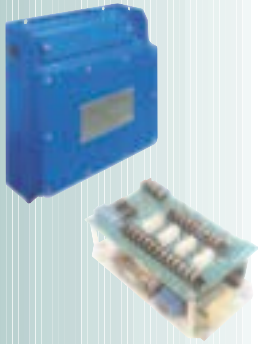

ATEX
M2/M1
GROUP I
INTRINSICALLY
SAFE

6 PRECAUTIONS

- Ensure that all covers on Exd housings and their fixing devices are properly secured in compliance with statutory Exd regulations before switching on the input supply.
- Never remove the cover of an Exd housing whilst the input supply is connected. Isolate elsewhere before removing the cover in accordance with statutory regulations.
- The housing of all power supplies must be securely earthed in compliance with statutory regulations.
- Carry out a current consumption audit to ensure that the maximum current loading of the power supply is not exceeded.
- Ensure that the installation of the power supply, particularly with regard to the connecting cables, complies with the certification parameters (section 7).
- Exd housings must be inspected and maintained regularly in accordance with statutory regulations.
- Use only the correct Trolex replacement fuses (section 7).
Do not substitute any form of equivalent or linking device.

Refer to Section 7

Refer to Section 7

- The TX6630 Series Exi Power Supply must be mounted in an approved Exd housing when located in a hazardous area.
- All cables entering the Exd housing must be terminated with suitable Exd certified cable glands.
- The cabling between the Power Supply and other approved intrinsically safe devices must comply with the cable parameters specified in the appropriate Ex certification of the device.
- Never connect two power supplies in parallel, or employ external circuitry that results in two Intrinsically Safe Power Supplies circulating in one system. This will contravene the limits of Intrinsic Safety.
- Where an Intrinsically Safe Power Supply is fitted with auxiliary Intrinsically Safe isolating relays, all the relay coils are powered from a common Intrinsically Safe source.

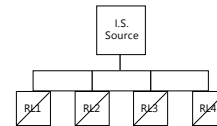

- If an ac input fuse is ruptured at any time, it can be replaced. It is recommended however, that a full investigation is carried out to try to establish the cause of the failure as this could indicate potentially dangerous external conditions.
- It is good practice to check the condition of the mating flame path surfaces on the Exd chamber cover whenever it is removed.
- Five x M25 threaded cable entries are provided on the underside of the Exd chamber for connecting the incoming Power Supply and for connections to relay contacts if these are fitted.

Approved Cable Glands:

Hawke: 650 series Compound Filled M25 Thread

Hawke: 650 series Compound Filled M20 Thread (when used with a M25/M20 reducer).

Approved Thread Reducers:

Hawke: 476/R, M25/M20 Thread

- All unused cable entries MUST be blanked off with an APPROVED STOPPING PLUG.

Approved Stopping Plugs:

Hawke: 475, M25 Thread

- The requirements of the Exd certification of the TX6620 Series Intrinsically Safe Power Supply demand that electrical isolation must be provided in the mains Power Supply feed. The isolation should be mounted adjacent to the Power Supply.
- The metal housing of the Power Supply, should be earthed in compliance with local regulations.
- Ensure that the mating faces of the Exd chamber cover are clean and free from inclusions before the cover is replaced. It is permissible to use copper grease on the mating faces to protect against corrosion and moisture ingress.

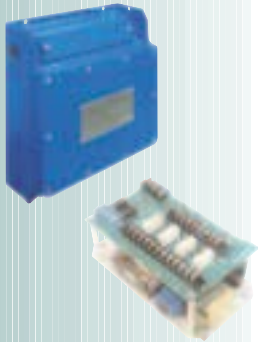

ATEX
M2/M1
GROUP I
INTRINSICALLY
SAFE

7 APPROVALS AND CERTIFICATION

7.1 Certification

The TX6630 and TX6620 Series Power Supplies are designed and approved to meet the ATEX directive (94/9/EC).

TX6620 – I M2 EEx d[ia] I

TX6630 – I (M1) [EEx ia] I



7.2 Electro Magnetic Compatibility

The TX6630 series Power Supplies are designed and tested to meet the requirements of the EMC directive (89/336/EC).



7.3 Low Voltage

The TX6630 series Power Supplies are designed and tested to meet the requirements of the Low Voltage directive (73/23/EC).

7.4 Certification Parameters

TX6635 7.5V Power Supply Chassis:-

Um = 375V peak

Uo = 9V dc

Io = 3.47A

Co = 100uF

Lo = 54uH

Po = 12.5W

TX6636 12V Power Supply Chassis:-

Um = 375V peak

Uo = 14.4V dc

Io = 2.37A

Co = 20uF

Lo = 100uH

Po = 9.84W

7.5 Special Conditions for Safe Use

TX6620

The electrical isolation must be provided in the mains Power Supply feed. The isolation should be mounted adjacent to the Power Supply.

If the cover fixing screws need to be replaced, the replacement screws will be of grade A2-70 stainless steel or stronger.

TX6630

If the apparatus is to be installed within a potentially explosive atmosphere, an additional alternative type of protection, as listed in EN 50014:1997 + amendments 1 & 2 must be provided - such as an appropriately certified flameproof enclosure.

If the apparatus is installed outside the potentially explosive atmosphere, it must be done so in an earthed metal enclosure providing a degree of protection of not less than IP20 as defined in EN 60529:1992.

7 APPROVALS AND CERTIFICATION *continued*

7.6 Compliance with ATEX Directives



Instructions specific to hazardous area installations (reference European ATEX Directive 94/9/EC, Annex II, 1.0.6.)

The following instructions apply to equipment covered by certificate numbers Baseefa 03ATEX0227X and Baseefa 03ATEX0732X:

1. The Power Supply Chassis must be housed in a suitably certified enclosure, or be located in a safe area, this is a special condition of certification. The TX6620, which is a TX6620 Chassis housed in a flameproof enclosure) may be located in a hazardous area with flammable gases and vapours with Group I apparatus.
2. The equipment is only certified for use in ambient temperatures in the range $-5^{\circ}\text{C} \dots +70^{\circ}\text{C}$ and should not be used outside this range.
3. Installation shall be carried out in accordance with the applicable code of practice by suitably trained personnel.
4. Replacement of fuses or repair of this equipment shall be carried out in accordance with the applicable code of practice.
5. Certification marking as detailed in drawing numbers P5111.75 and P5111.76.
6. If the equipment is likely to come into contact with aggressive substances, then it is the responsibility of the user to take suitable precautions that prevent it from being adversely affected, thus ensuring that the type of protection is not compromised.

Aggressive Substances - e.g. acidic liquids or gases that may attack metals or solvents that may affect polymeric materials.

Suitable Precautions - e.g. regular checks as part of



Bedingungen für die Installation in explosionsgefährdeten Räumen (Europäische ATEX-Richtlinie 94/9/EC, Zusatz II, 1.0.6.)

Die folgenden Bedingungen gelten für Geräte mit den Zertifikationsnummern Baseefa 03ATEX0227X und Baseefa 03ATEX0732X:

1. Das Netzteilchassis muss in einem entsprechend zertifizierten Gehäuse eingebaut bzw. in einem sicheren Bereich positioniert werden; dieser Punkt ist eine spezielle Bedingung der Zertifizierung. Das TX6620, ein TX6620 Chassis, das in einem feuerbeständigen Gehäuse untergebracht ist) kann mit Geräten der Gruppe I in explosionsgefährdeten Bereichen, in denen entflammbare Gase und Dämpfe präsent sind, positioniert werden.
2. Das Gerät ist nur für den Einsatz bei Umgebungstemperaturen von -5°C bis $+70^{\circ}\text{C}$ zertifiziert und darf außerhalb dieses Bereiches nicht eingesetzt werden.
3. Installation muss nach den jeweils geltenden Betriebsvorschriften von qualifizierten Personen vorgenommen werden.
4. Wechseln von Sicherungen und Reparaturen müssen nach den jeweils geltenden Betriebsvorschriften ausgeführt werden.
5. Zertifikationsmarkierungen entsprechen Zeichnungsnummern P5111.75 und P5111.76.
6. Falls die Gefahr besteht, dass das Gerät mit aggressiven Substanzen in Kontakt kommt, obliegt es dem Benutzer, entsprechende Maßnahmen zu treffen, dass es nicht beschädigt und der Geräteschutz nicht beeinträchtigt wird.

Aggressive Substanzen - z.B. säurehaltige Flüssigkeiten oder Gase, die Metalle angreifen, bzw. Lösungsmittel die Polymerstoffe zersetzen.

Geeignete Vorkehrungen - z.B. regelmäßige

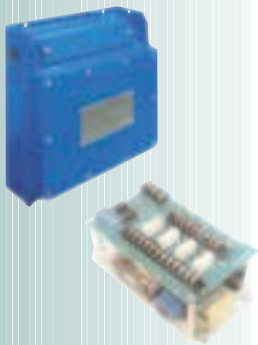

**ATEX
M2/M1
GROUP I
INTRINSICALLY
SAFE**

7 APPROVALS AND CERTIFICATION *continued*



E

Instrucciones específicas para instalaciones en áreas peligrosas (con referencia a la Directiva Europea ATEX 94/9/CE, anexo ii,1.0.6)

Las siguientes instrucciones son aplicables a los equipos cubiertos por los certificados Baseefa 03ATEX0227X y Baseefa 03ATEX0732X:

1. El bastidor de Alimentación de Energía Eléctrica deberá estar colocado en un recinto adecuadamente certificado, o ubicado en un área de seguridad; esta es una condición especial de certificación. El TX6620, el cual es un TX6620 Chassis colocado en un recinto a prueba de fuego) puede ser ubicado en un área peligrosa con gases inflamables y vapores, con aparatos del Grupo I.
2. El equipo solo está certificado para ser utilizado en temperaturas ambientes en un margen dentro de los -5°C y $+70^{\circ}\text{C}$ y no deberá ser utilizado fuera de este margen.
3. La instalación deberá ser realizada de acuerdo con el correspondiente código de práctica y por personal adecuadamente entrenado.
4. El reemplazo de fusibles o la reparación de este equipo deberá ser realizada de acuerdo con el correspondiente código de práctica.
5. Marcas de certificación como se detalla en el trazado número P5111.75 y P5111.76.
6. Si existe alguna posibilidad de que el equipo entre en contacto con sustancias agresivas, será la responsabilidad del usuario el tomar precauciones que lo prevengan de ser afectado desfavorablemente, y por consiguiente asegurarse de no arriesgar el tipo de protección.

Substancias Agresivas - por ejemplo, líquidos ácidos o gases que puedan atacar metales, o



NL

Instructies met specifieke betrekking op installaties voor gevaarlijke ruimten (naar Europese ATEX Richtlijn 94/9/EC, Bijlage II, 1.0.6.)

De volgende instructies zijn van toepassing op onder Certificaat nummer Baseefa 03ATEX0227X en Baseefa 03ATEX0732X vallende apparatuur:

1. De stroomvoorzieningschassis moet ondergebracht worden in een officieel geschikt verklaarde behuizing of in een veilige ruimte: dit is een speciale voorwaarde voor certificering. De TX6620, oftewel een TX6620 Chassis ondergebracht in een vlamveilige behuizing) mag in een gevaarlijke ruimte met vlambare gassen en dampen worden ondergebracht met apparatuur van Groep I.
2. De apparatuur is alleen officieel geschikt verklaard voor gebruik bij een omgevingstemperatuur tussen -5°C en $+70^{\circ}\text{C}$ en mag niet gebruikt worden buiten deze minimum- en maximumtemperaturen.
3. Installatiewerkzaamheden dienen uitgevoerd te worden door geschikt opgeleid personeel in overeenstemming met de van toepassing zijnde praktijkcode.
4. Het vervangen van smeltveiligheden en reparatiewerkzaamheden dienen uitgevoerd te worden in overeenstemming met de van toepassing zijnde praktijkcode.
5. Markering van de certificering volgens Tekening P5111.75 en P5111.76.
6. Als het waarschijnlijk is dat de apparatuur in aanraking zal komen met agressieve stoffen, dan is het de verantwoordelijkheid van de gebruiker om geschikte voorzorgsmaatregelen te nemen om te voorkomen dat de apparatuur aangetast wordt en er zo voor te zorgen dat het type bescherming niet in gevaar gebracht wordt.

Agressieve stoffen – bijv. zure vloeistoffen of gassen die metalen kunnen aantasten ofwel oplossingen die een vergelijkbaar effect kunnen hebben op polymeren stoffen.

Geschikte voorzorgsmaatregelen – bijv. regelmatig controleren als onderdeel van routine inspecties of naar aanleiding van het gegevensblad voor

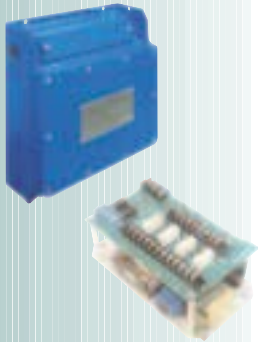

ATEX
M2/M1
GROUP I
INTRINSICALLY
SAFE

7 APPROVALS AND CERTIFICATION *continued*



Spesifikk informasjon for installasjoner i eksplosjonsfarlige områder (ref. Europeisk ATEX Direktiv 94/9/EC, Bilag II, 1.0.6.)

Følgende instruksjer gjelder for utstyr dekket av sertifikatnummer Baseefa 03ATEX0227X og Baseefa 03ATEX0732X:

1. Kraftforsyningschassiset må plasseres i en passende sertifisert kasse, eller plasseres på et ikke-eksplosjonsfarlig område, dette er en betingelse for sertifiseringen. TX6620, som er en TX6620 Chassis plassert i en flammesikker kasse) kan plasseres på et eksplosjonsfarlig område med brannfarlige gasser og damp med Gruppe 1 apparater.
2. Utstyret er kun sertifisert for bruk i omgivelsestemperaturer fra -5°C til $+70^{\circ}\text{C}$ og må ikke brukes utenfor disse temperaturområdene.
3. Innstallering må utføres av kompetent personale ifølge gjeldende regler.
4. Utskifting av sikringer eller reparasjoner på dette utstyret må kun utføres ifølge gjeldende regler.
5. Sertifiseringsmerkingen vises på tegninger nummer P5111.75 og P5111.76.
6. Hvis utstyret sannsynligvis vil komme i kontakt med aggressive stoffer så er det brukerens ansvar å ta passende forholdsregler for å unngå at det blir skadet, og således sikre at beskyttelsen ikke forringes.

Aggressive stoffer - f.eks. etsende væsker og gasser som kan angripe metaller eller løsemidler som kan påvirke polymeriske materialer.

Passende forholdsregler - f.eks. regelmessig inspeksjon som en del av rutinesjekking eller fastslå fra materialets dataark at det er motstandsdyktig mot



Norme specifiche alle installazioni in zone a rischio (riferimento Direttiva Europea ATEX 94/9/EC, Allegato II, 1.0.6.)

Le norme che seguono si applicano alle apparecchiature disciplinate dai certificati n. Baseefa 03ATEX0227X e Baseefa 03ATEX0732X:

1. Il telaio dell'alimentatore deve essere alloggiato in un contenitore idoneamente omologato, od essere sistemato in una zona sicura; questa è una condizione specifica della certificazione. Il tipo TX6620, che è la versione del TX6620 Chassis alloggiata in un contenitore antideflagrante) può essere sistemato in una zona a rischio con gas e vapori infiammabili con apparecchiature del Gruppo I.
2. L'apparecchio è certificato solo per l'utilizzo ad una temperatura ambiente compresa tra -5°C e $+70^{\circ}\text{C}$ e non deve essere usato al di fuori di questo campo.
3. L'installazione deve essere eseguita in conformità al codice di procedura pertinente da personale opportunamente addestrato.
4. La sostituzione dei fusibili o la riparazione di questo apparecchio devono essere eseguite in conformità al codice di procedura pertinente.
5. La marcatura di certificazione è quella indicata sui disegni numero P5111.75 e P5111.76.
6. Se è probabile che l'apparecchio venga a contatto con sostanze aggressive, è compito dell'utente prendere precauzioni idonee a impedire che ne sia attaccato, garantendo così che il tipo di protezione non venga compromesso.

Sostanze aggressive sono, ad esempio, liquidi o gas acidi che possono attaccare i metalli, o solventi che possono colpire i materiali polimerici.

Precauzioni idonee sono, ad esempio, controlli regolari che fanno parte di ispezioni ordinarie, o informazioni reperite dalla scheda tecnica del



**ATEX
M2/M1
GROUP I
INTRINSICALLY
SAFE**

INSTALLATION & OPERATING DATA

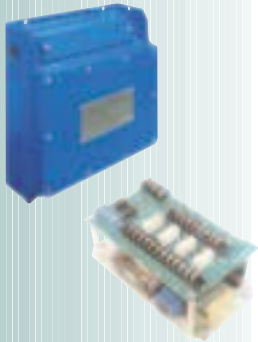

PROTECTING THE ENVIRONMENT



Many of our products are often used to monitor the quality of environmental conditions consequently Trolex is also particularly aware of the need to protect human health and the environment in which we live.

The Company has instituted a radical environment protection policy to ensure that all aspects of our manufacturing programme have the minimum possible detrimental impact on the environment. This covers all stages beginning with sustainable product design supported by careful selection of the materials used in their production, through to managed recovery and disposal at the end of the useful life of a product.

This policy also incorporates the principles of the Waste Electrical and Electronics Equipment (WEEE) directive, and the associated Restriction of Hazardous Substances (RoHS) directive, to be implemented in EU countries.

Progress is already well advanced on the introduction of a completely new range of products that maximise the central principle of sustainable design with the intention of reducing the end-of-life cost to the end user.

All Trolex products are manufactured to exacting standards in accordance with our stringent quality control ethos. Having chosen to use one of our products will, in itself, guarantee extended durability and a long operating life, endorsed by our commitment to recycling and recovery.

- All packaging materials are carefully selected to be bio-degradable or re-cycleable where possible.
- All plastic materials are identified for recycling purposes and re-cycled materials are used where it is possible to do so.

- Printing paper and material are sourced from suppliers that have a declared environmental management system.
- Product design centred around high quality and long term durability.
- Modular architecture both in construction and software design suitable for future upgrades and adaptability to alternative duty.
- Ease of product disassembly, minimisation of fixing devices, and clear separation of functional parts to benefit re-use and recycling.
- Control and monitoring of suppliers of components and sub-assemblies.
- Deal only with suppliers that have a defined commitment to environmental monitoring principles.
- Control the use of restricted substances within the design process. Deal only with suppliers that have a defined commitment to the control of restricted substances.
- Provide an efficient high speed service within Trolex for repair, refurbishing and conversion of products for alternative duty.
- Provision of an end-of-life product Take-back service for recovery, re-use, and recycling of electrical and electronic components. Retain the packaging of a new product and re-use it to return the device to us at the end of its working life. Trolex will guarantee to recover all materials and components, where practicable and arrange for them to be re-cycled in an appropriate and in a safe manner.



ATEX
M2/M1
GROUP I
INTRINSICALLY
SAFE